



all rights reserved

GVWR 850kg - 1500kg

by: Piotr Goral

model year 2023

CarbonTear MK1<sup>®</sup>

XR

ARCTIC



all rights reserved

GVWR 850kg - 1500kg

by: Piotr Goral

model year 2023

CarbonTear MK I <sup>®</sup>

XR

ARCTIC



all rights reserved

GVWR 850kg - 1500kg

by: Piotr Goral

model year 2023

CarbonTear MK I <sup>®</sup>

XR

ARCTIC

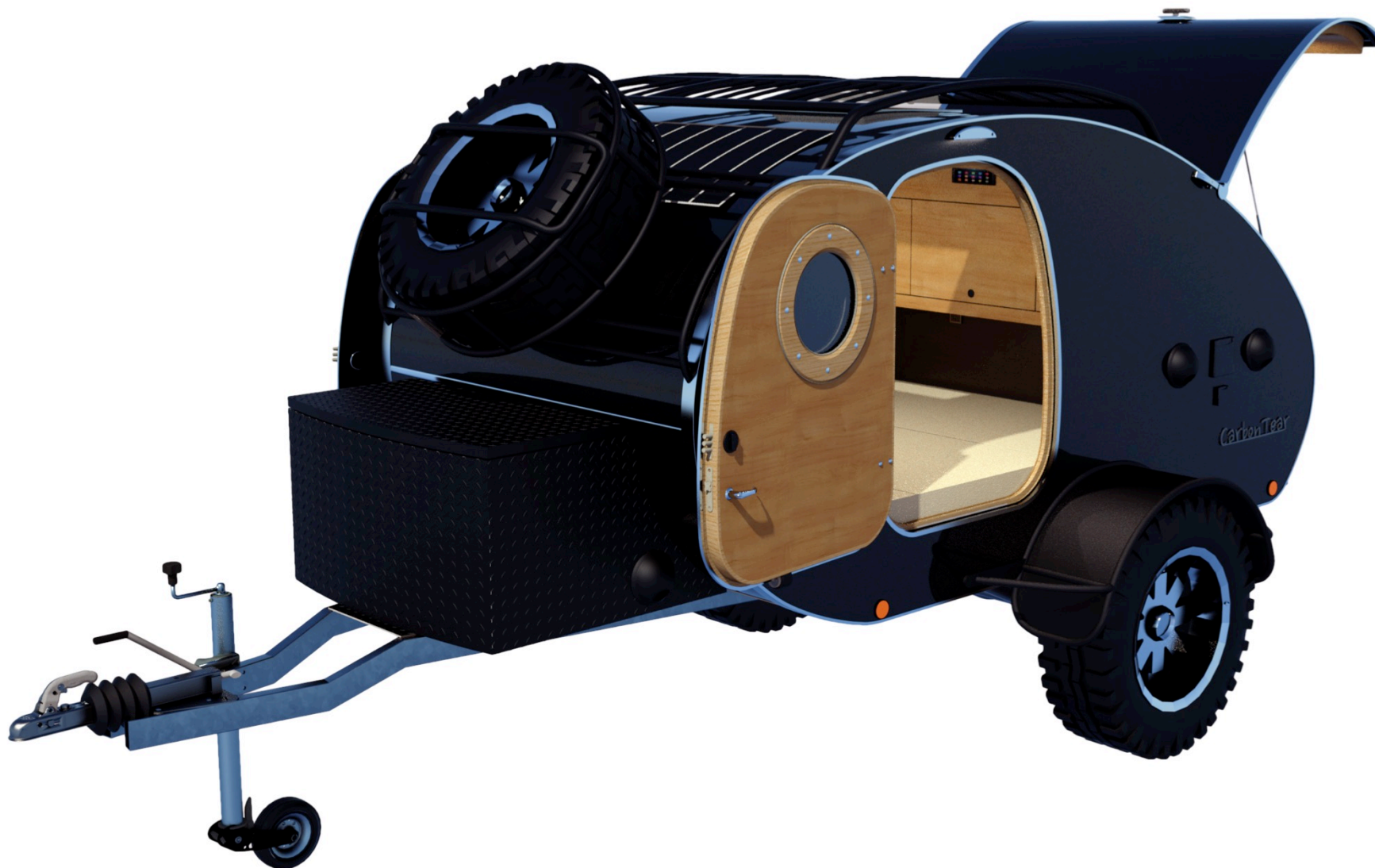

all rights reserved

GVWR 850kg - 1500kg

by: Piotr Goral

model year 2023

CarbonTear MK I <sup>®</sup>

XR

ARCTIC

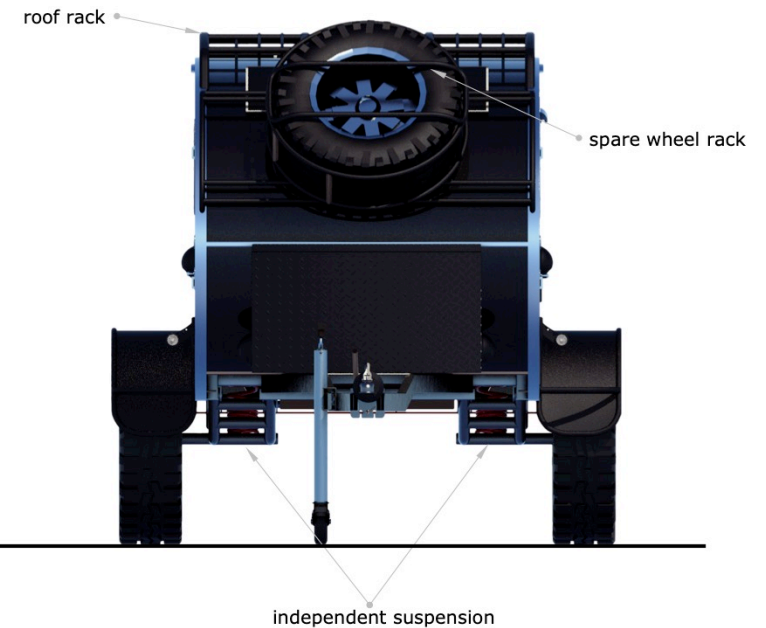
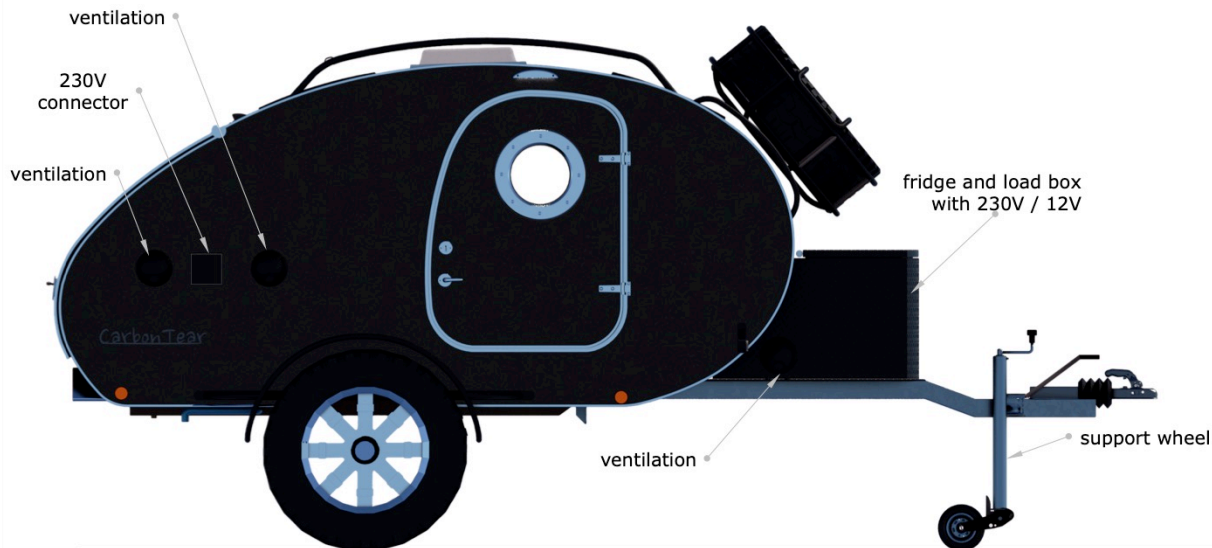
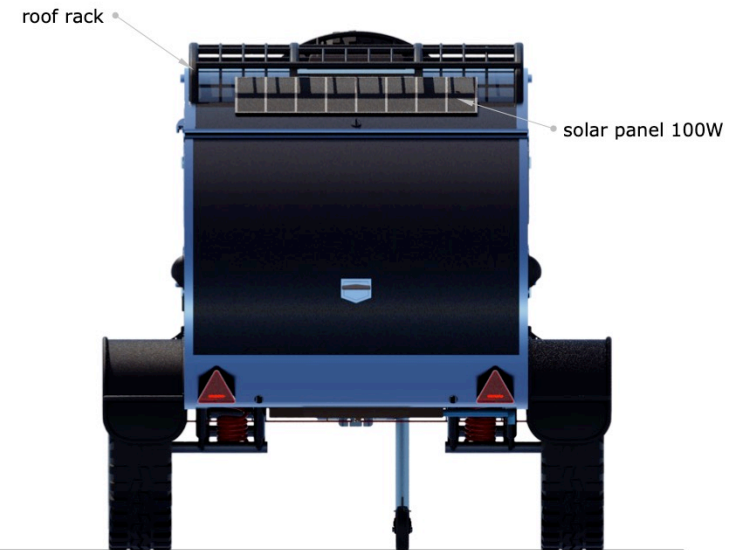
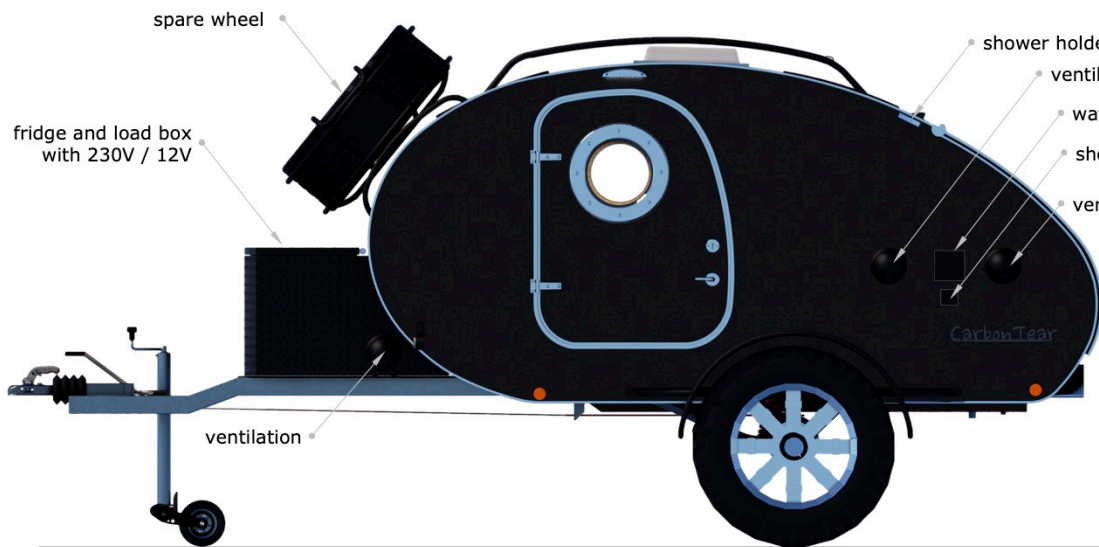

all rights reserved

GVWR 850kg - 1500kg

by: Piotr Goral

model year 2023

CarbonTear MK1 <sup>®</sup>

XR

ARCTIC

total length - 4780 mm  
 total width - 2200 mm  
 total height - 2240 mm  
 ride height - 600 mm

cabin length - 2040 mm  
 cabin width - 1510 mm  
 cabin height - 1180 mm

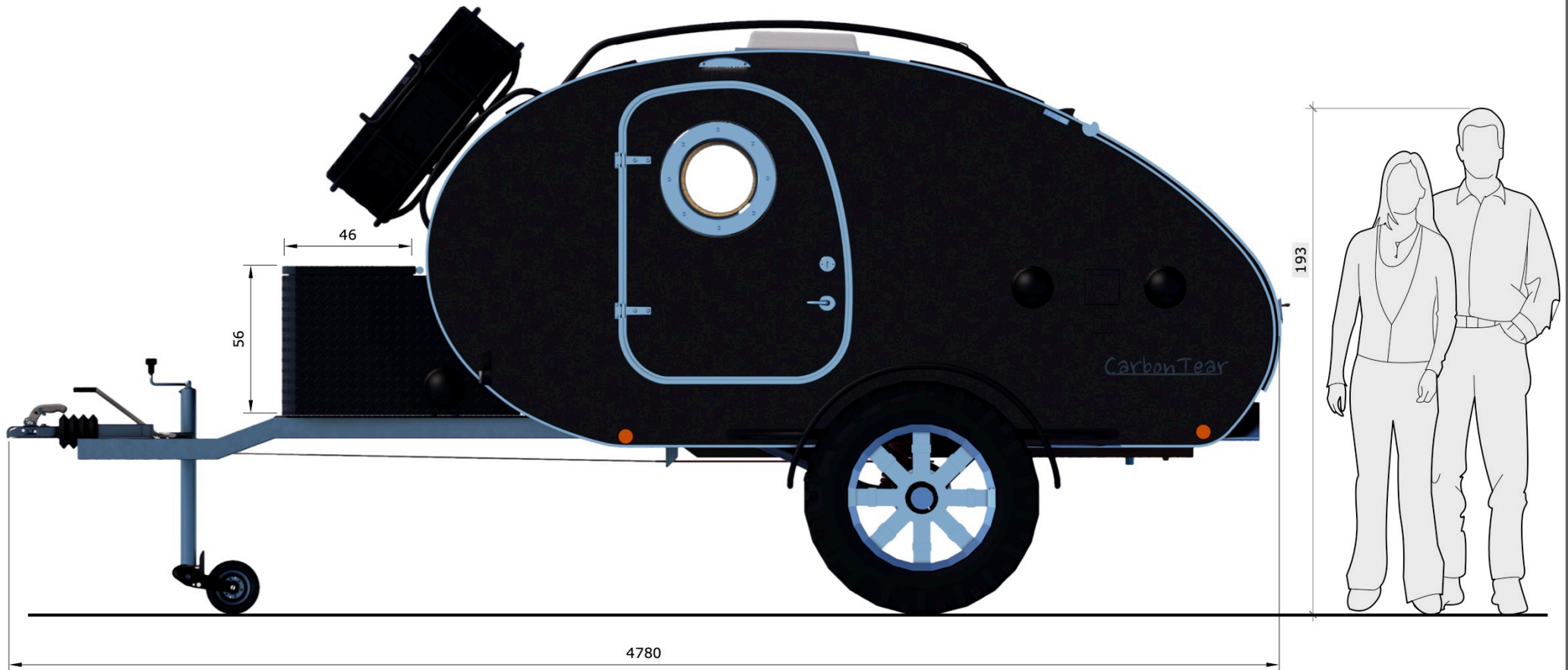

all rights reserved	dimensions	CarbonTear MK I <sup>®</sup>	XR
by: Piotr Goral	model year 2023		ARCTIC

total length - 4780 mm  
total width - 2200 mm  
total height - 2240 mm  
ride height - 600 mm

cabin length - 2040 mm  
cabin width - 1510 mm  
cabin height - 1180 mm



all rights reserved

dimensions

XR

by: Piotr Goral

model year 2023

CarbonTear MK I <sup>®</sup>

ARCTIC

total length - 4780 mm  
 total width - 2200 mm  
 total height - 2240 mm  
 ride height - 600 mm

cabin length - 2040 mm  
 cabin width - 1510 mm  
 cabin height - 1180 mm

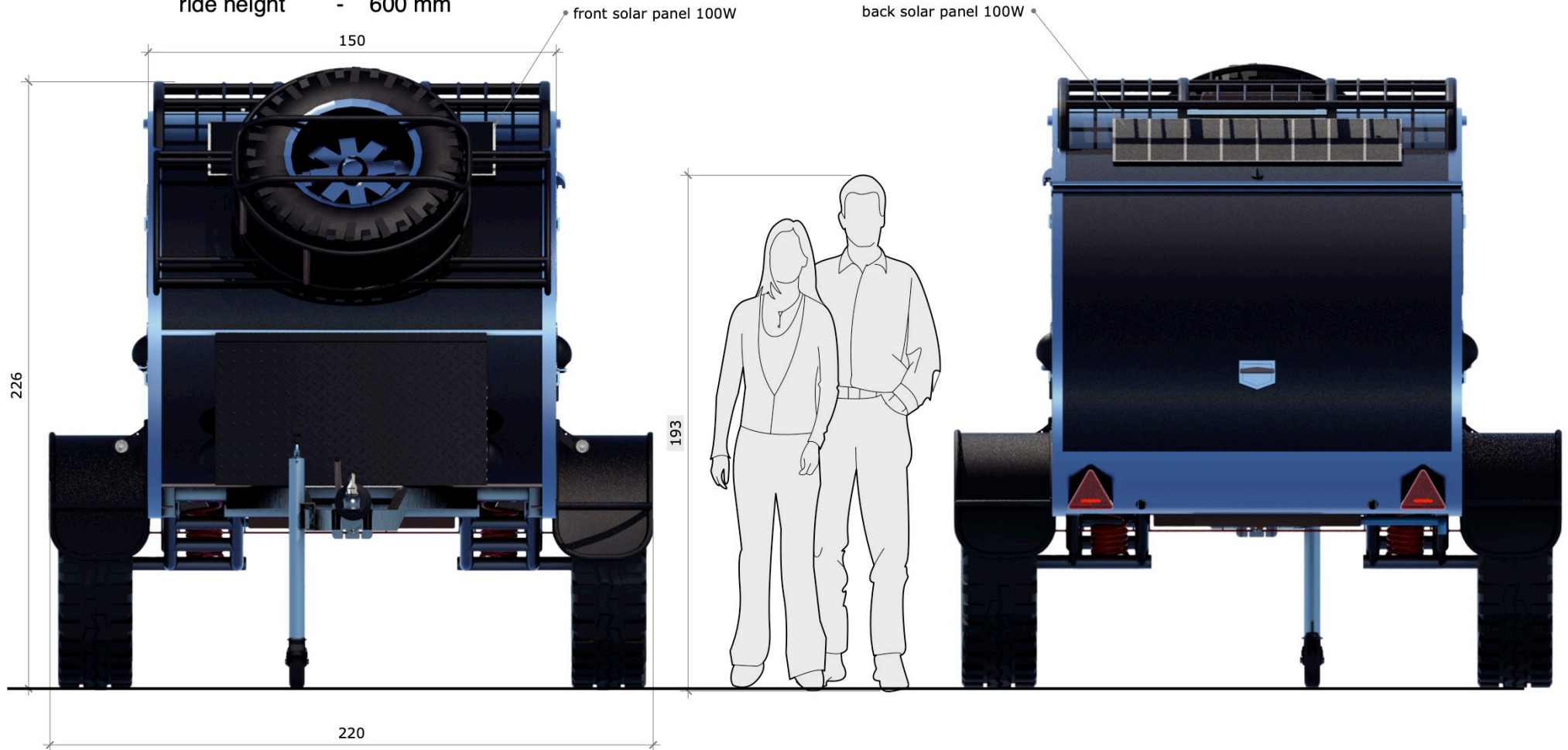

all rights reserved

dimensions

XR

by: Piotr Goral

model year 2023

Carbondtear MK I <sup>®</sup>

ARCTIC



total length - 4780 mm  
 total width - 2200 mm  
 total height - 2240 mm  
 ride height - 600 mm

cabin length - 2040 mm  
 cabin width - 1510 mm  
 cabin height - 1180 mm

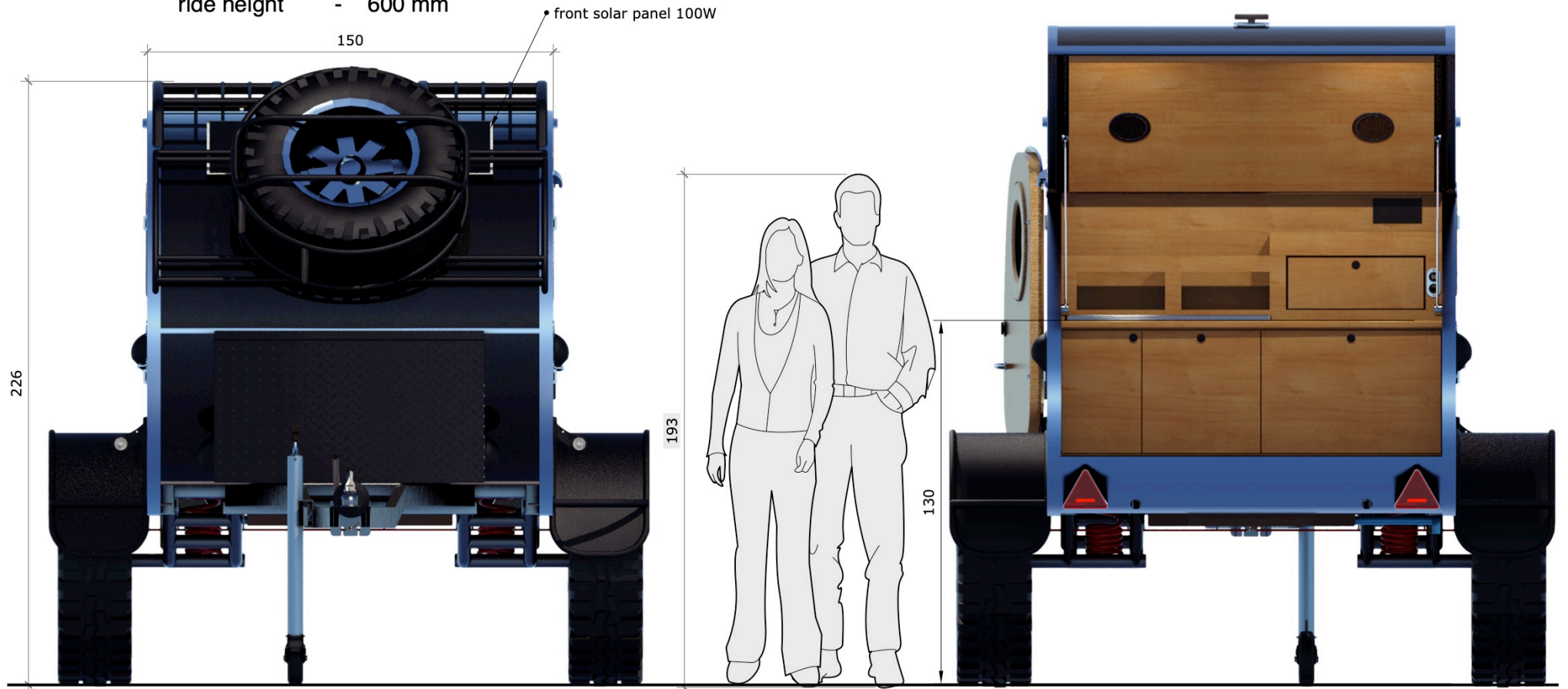

all rights reserved

dimensions

Carbondtear MK I <sup>®</sup>

XR

by: Piotr Goral

model year 2023

ARCTIC

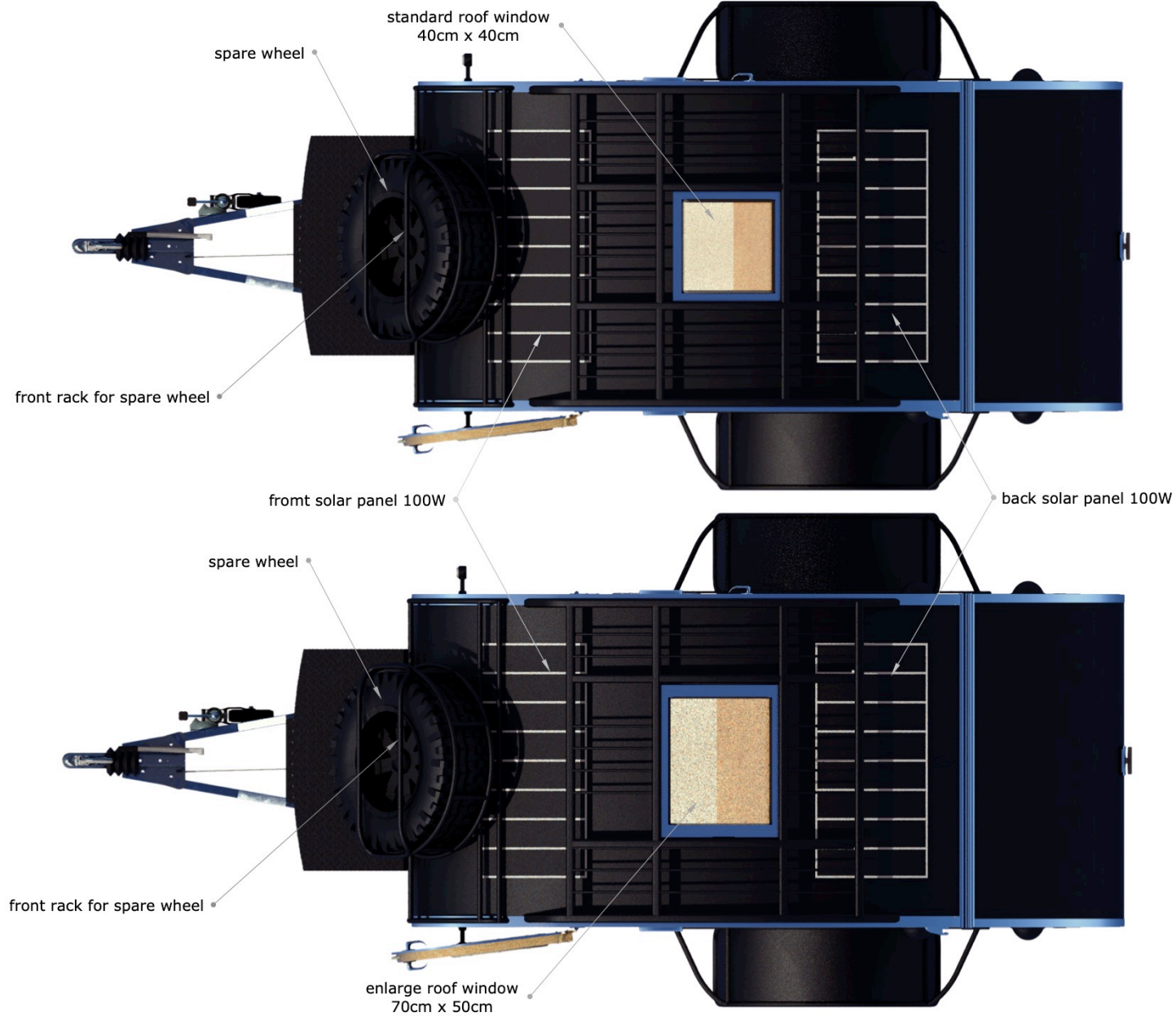

all rights reserved

roof window

XR

by: Piotr Goral

model year 2023

Carbontear MK I <sup>®</sup>

ARCTIC



10 cm materace 200cm x 140cm

protection net

kid bed 140cm x 60cm

200

420

990

140

193

gas stove

sink

all rights reserved

sleeping room

by: Piotr Goral

model year 2023

Carbontear MK I <sup>®</sup>

XR

ARCTIC



all rights reserved

sleeping room

by: Piotr Goral

model year 2023

Carbondtear MK I <sup>®</sup>

XR

ARCTIC

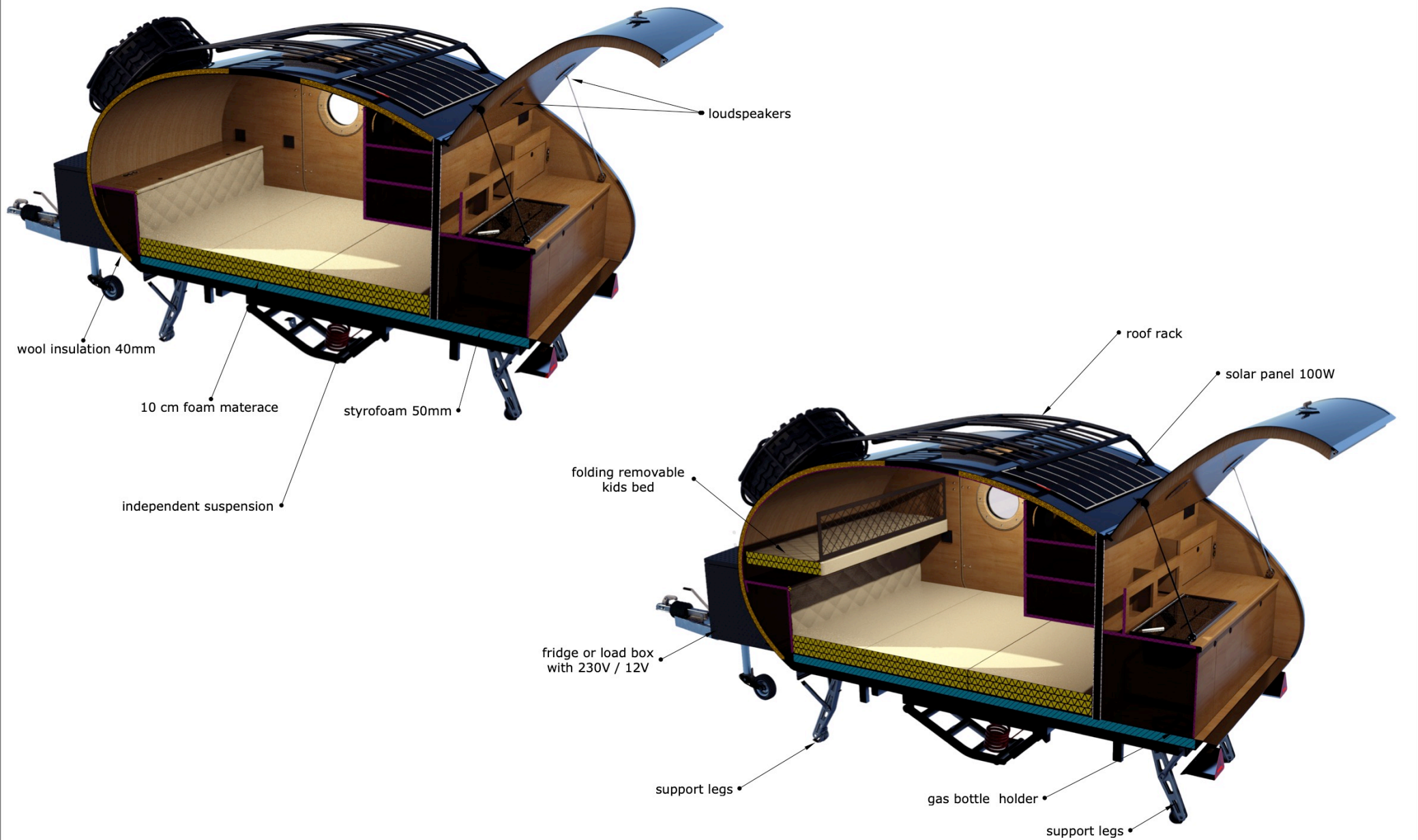

all rights reserved

A-A cut

by: Piotr Goral

model year 2023

Carbontear MK I <sup>®</sup>

XR

ARCTIC

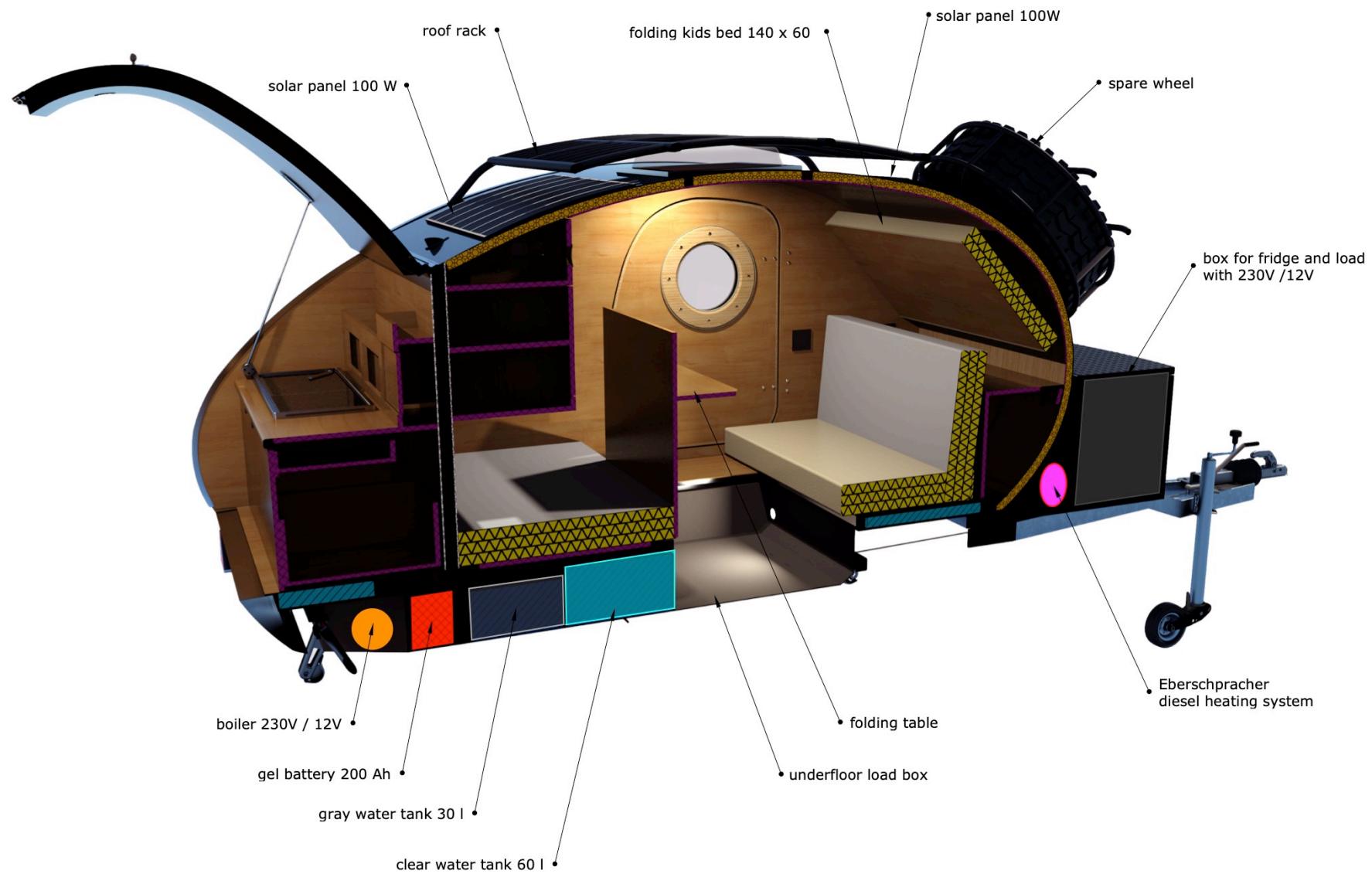

all rights reserved

A-A cut

by: Piotr Goral

model year 2023

Carbondtear MK I <sup>®</sup>

XR

ARCTIC



gas bottle not included

all rights reserved

kitchen

Carbontear MK I <sup>®</sup>

XR

by: Piotr Goral

model year 2023

ARCTIC

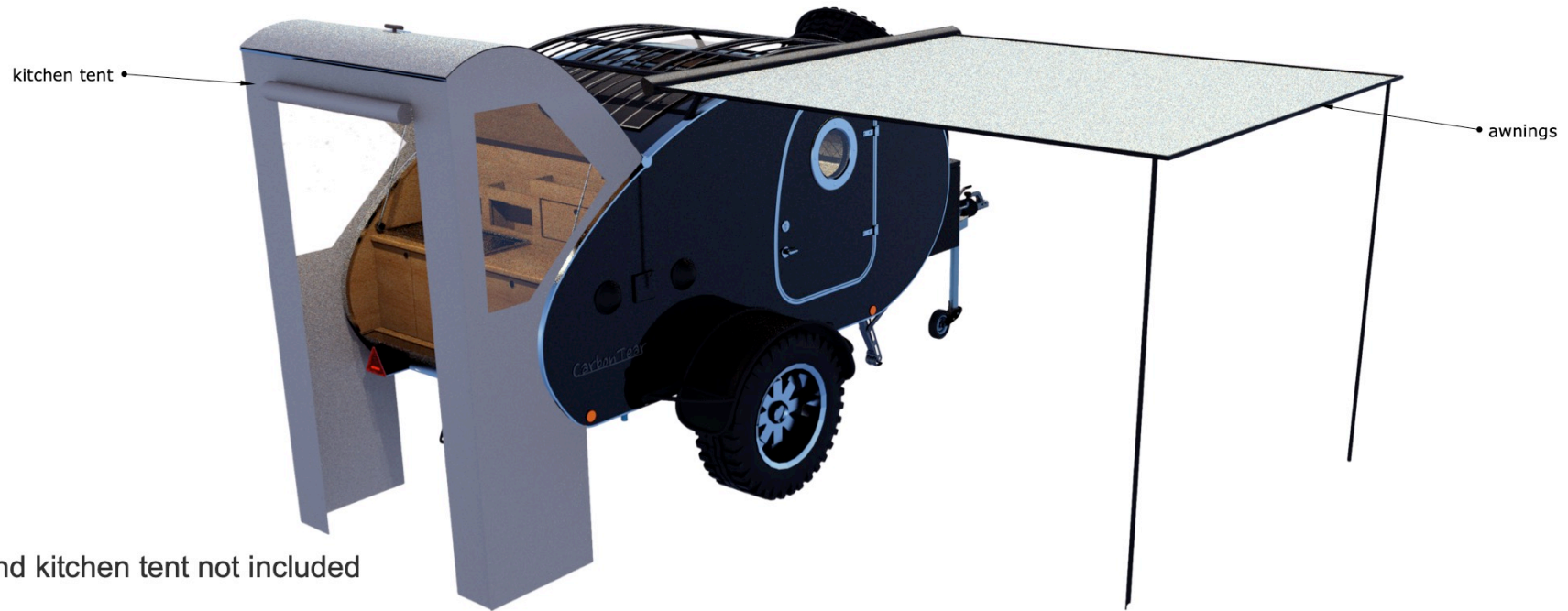
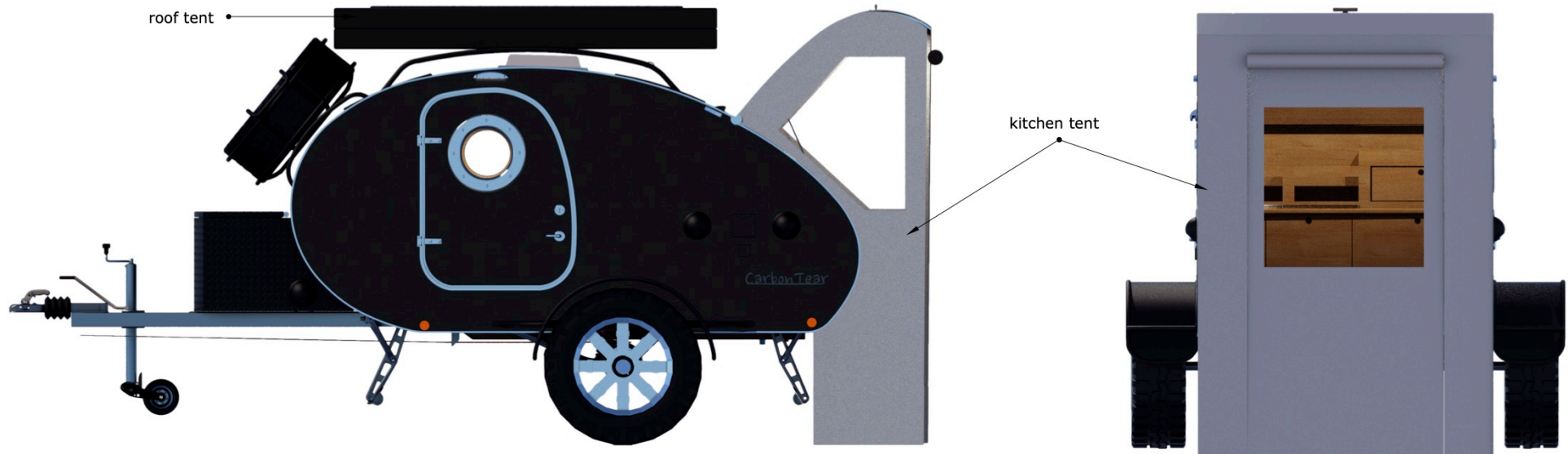

awnings and kitchen tent not included

all rights reserved

kitchen tent and awnings

by: Piotr Goral

model year 2023

CarbonTear MK1<sup>®</sup>

XR

ARCTIC



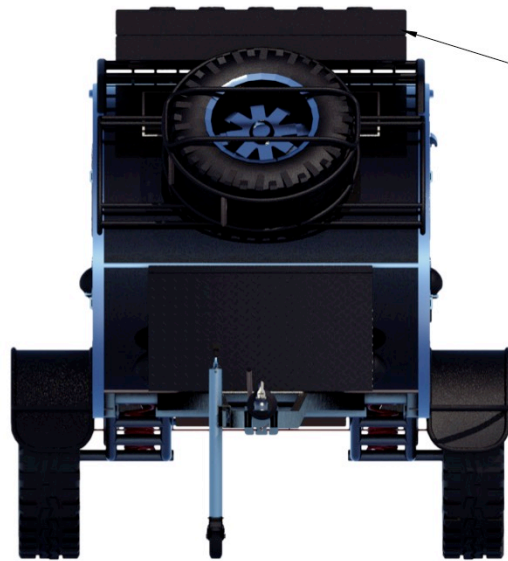

roof tent

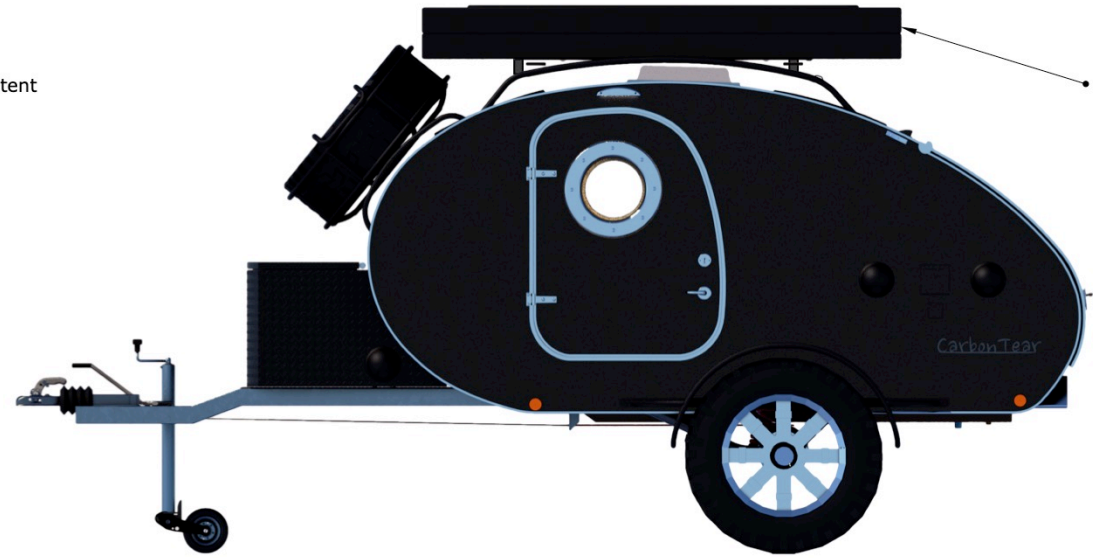

roof tent



roof tent

roof tent not included

all rights reserved

roof tent

by: Piotr Goral

model year 2023

CarbonTear MK1<sup>®</sup>

XR

ARCTIC

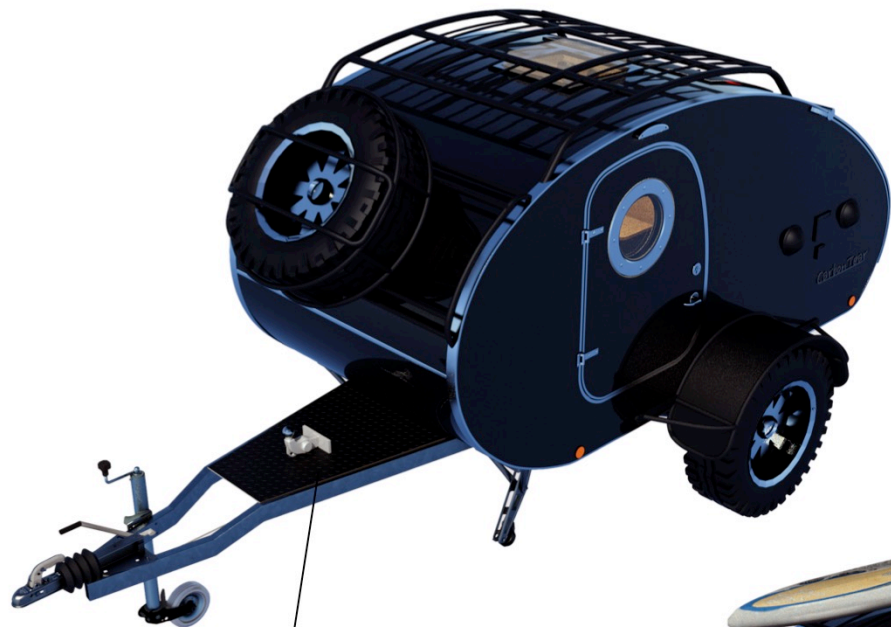

standard tow hook  
for bike rack

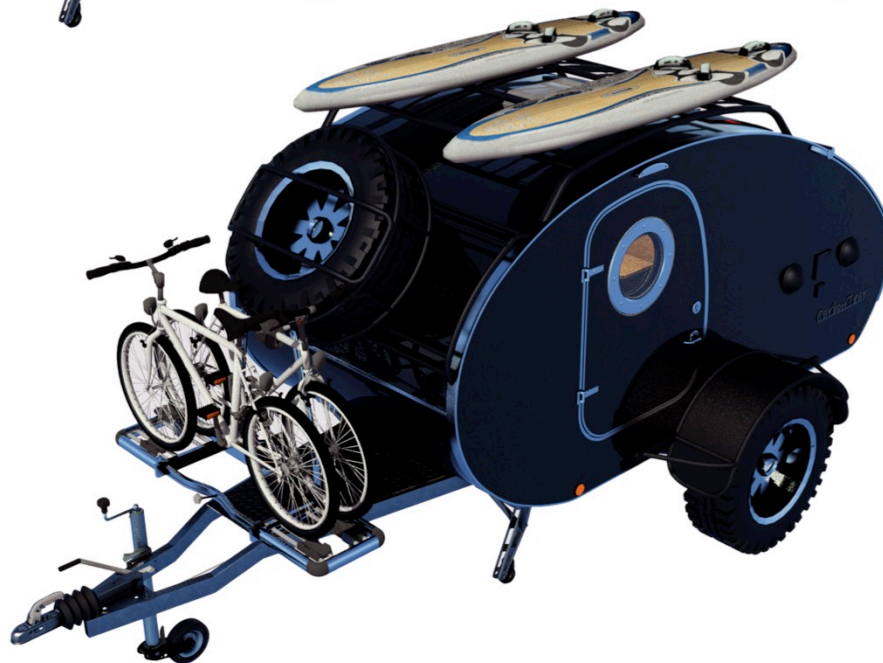

bikes and surfing not included

all rights reserved

bikes and surfing

by: Piotr Goral

model year 2023

CarbonTear MK1<sup>®</sup>

XR

ARCTIC

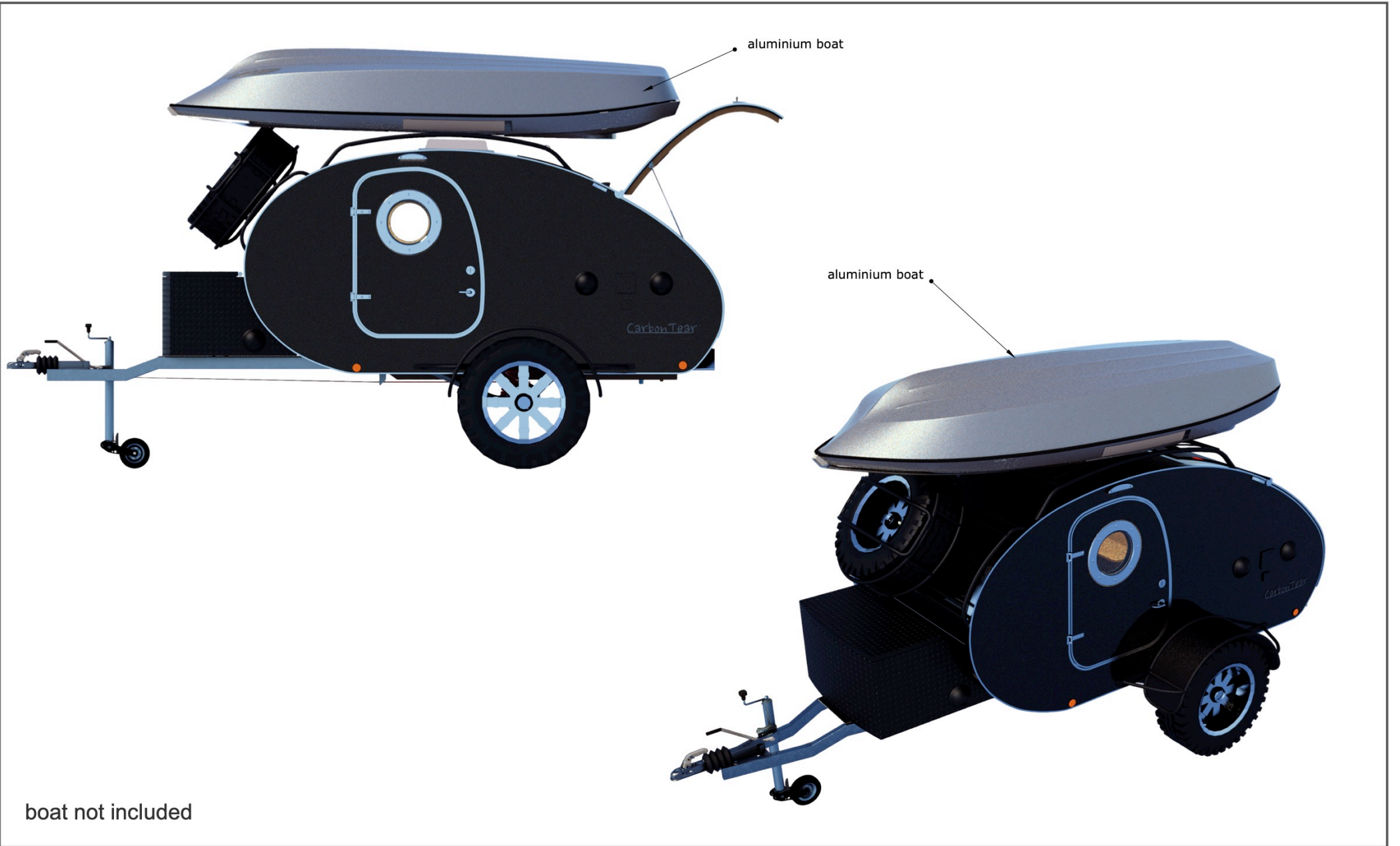

boat not included

all rights reserved	aluminium boat	CarbonTear MK1 <sup>®</sup>	XR
by: Piotr Goral	model year 2023		ARCTIC



all rights reserved

body colours

by: Piotr Goral

model year 2023

Carbontear MK I <sup>®</sup>

XR

ARCTIC

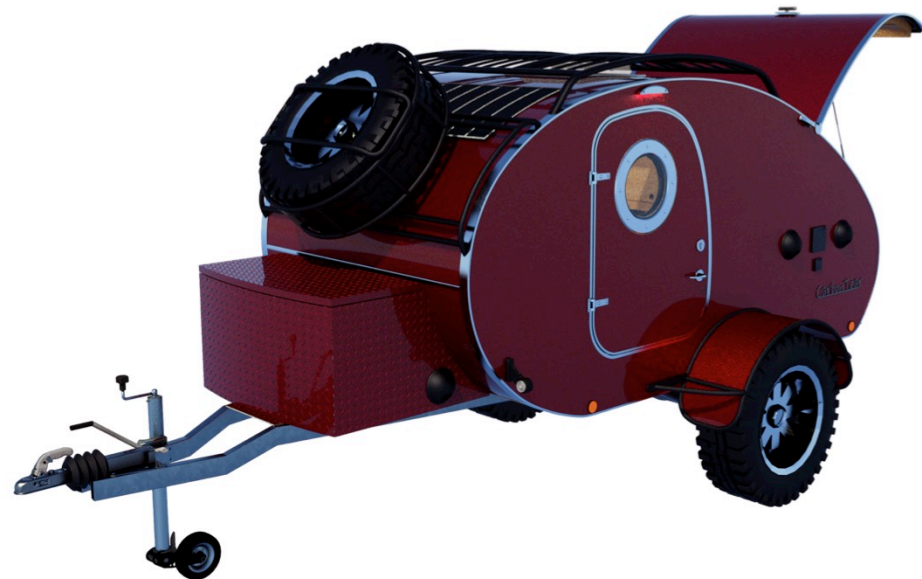
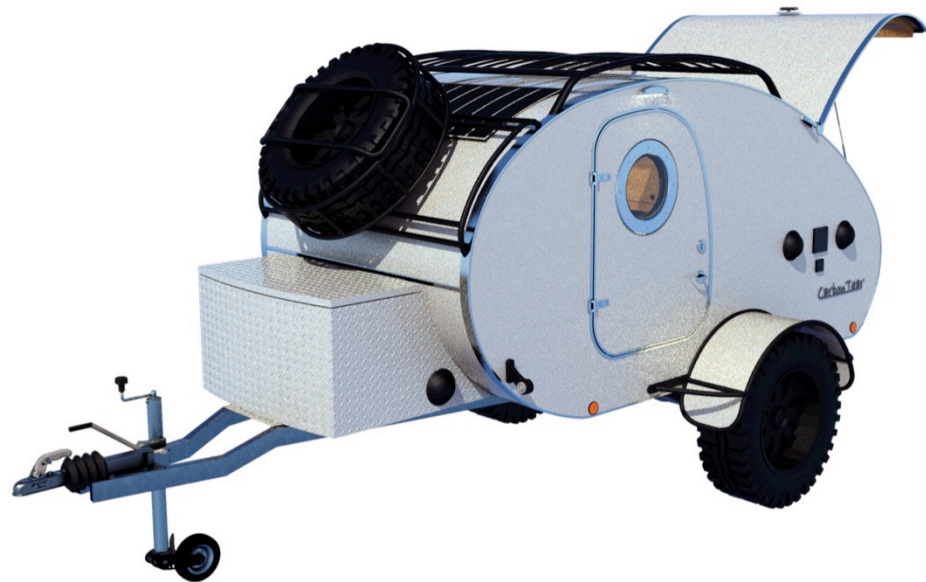
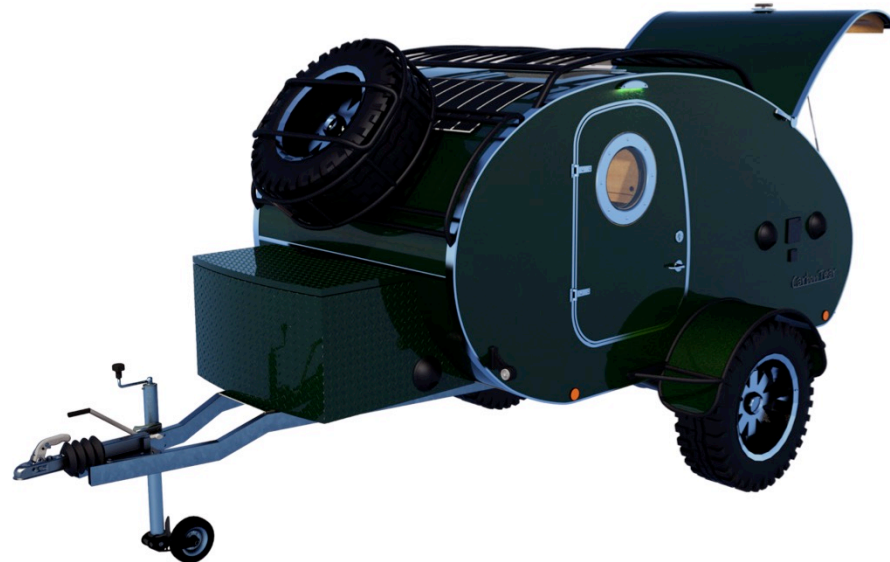
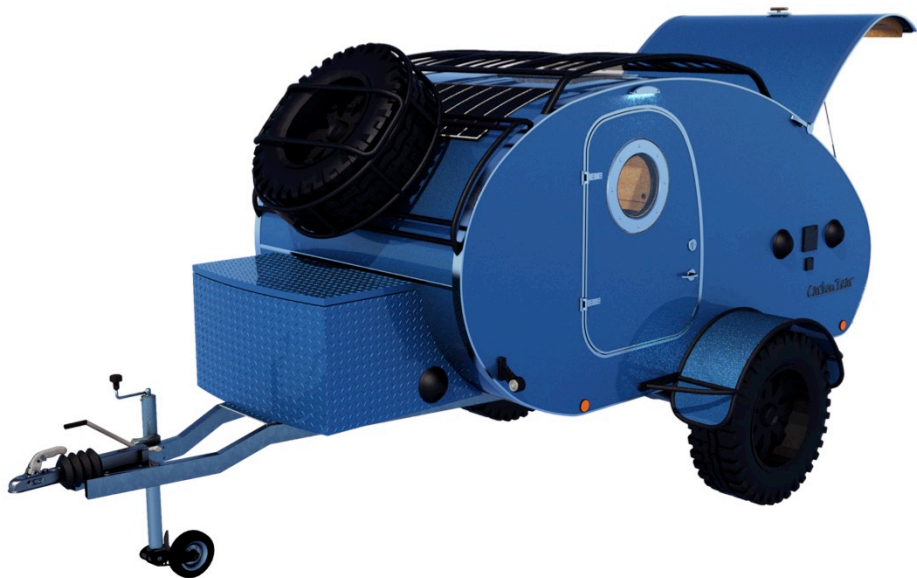

all rights reserved

body colours

by: Piotr Goral

model year 2023

CarbonTear MK1<sup>®</sup>

XR

ARCTIC

textile upholstery



all rights reserved

upholstery

by: Piotr Goral

model year 2023

Carbontear MK I <sup>®</sup>

XR

ARCTIC



Satin Black Pro Comp 5129



HE900 Gloss Black Helo



XD 129 Holeshoot Satin



Yokohama Geolandar AT G015



West Lake SL 366 MT



Cooper Discoverer S/T MAXX

all rights reserved

wheels 315/70R17

by: Piotr Goral

model year 2023

Carbontear MK I <sup>®</sup>

XR

ARCTIC

## Specification in STANDARD: 26 700 Euro

- chassis steel covered by zink
- body construction ash wood frame
- independent suspension with brakes
- alloy rims 16 " / 17"
- 35" tyres
- spare wheel with roof rack
- supporting feet x 4
- interior finishing – oak veneer
- materace with upholstery
- external wall finishing wrap foil
- roof finishing wrap foil
- details, finishing stripes brushed aluminium
- led lights x 6
- sleeping room furnishing with oak veneer
- kitchen furnishing with oak veneer
- folding table in the floor
- opening skylight 40cm / 40cm
- 12V/230V electrics
- external 230V connector
- 200 W solar panel
- 200Ah gel battery
- audio system with 4 speakers
- 12/230 V boiler combo
- 12V charge socket x 2
- USB port x 4
- Dometic 2 stove kitchen with sink
- gas bottle holder
- roof rack 150 kg
- water tank 60 l gray water
- water tank 30 l clear water
- external shower connector with shower device
- front box on drawbar with 230V / 12V sockets

STANDARD	26 700 Euro
----------	-------------

### Options:

Webasto heating system with remote control	1 600 Euro
kids bed 140cm x 60cm	400 Euro
awnings THULE OMNISTOR 260cm x 260cm	1 300 Euro
awnings DOMETIC 260cm x 260cm	800 Euro
enlarge roof widow Dometic 70cm x 50cm	350 Euro
coupling device with stabilizer	320 Euro
Dometic fridge 31 l	850 Euro
roof tent basic	1 750 Euro
cutlery drawer	650 Euro
hook for bicycle rack on towbar	320 Euro
roof boat holder	540 Euro

Price in Euro for standard specification 26 700 EURO  
excluded VAT tax

time of manufacturing 12 weeks from order

loco: Lublin Poland

all rights reserved	specification	CarbonTear MK I <sup>®</sup>	XR
by: Piotr Goral	model year 2023		ARCTIC



Carbontear

.....

Dealer

.....

ORDER

date

Carbontear MK I <sup>®</sup>

XR

ARCTIC