



all rights reserved

GVWR 750kg - 1000kg

by: Piotr Goral

model year 2023

CarbonTear MK I [®]

XR

NOMAD



all rights reserved

GVWR 750kg - 1000kg

by: Piotr Goral

model year 2023

CarbonTear MK I [®]

XR

NOMAD



all rights reserved

GVWR 750kg - 1000kg

by: Piotr Goral

model year 2023

Carbon Tear MK I [®]

XR

NOMAD

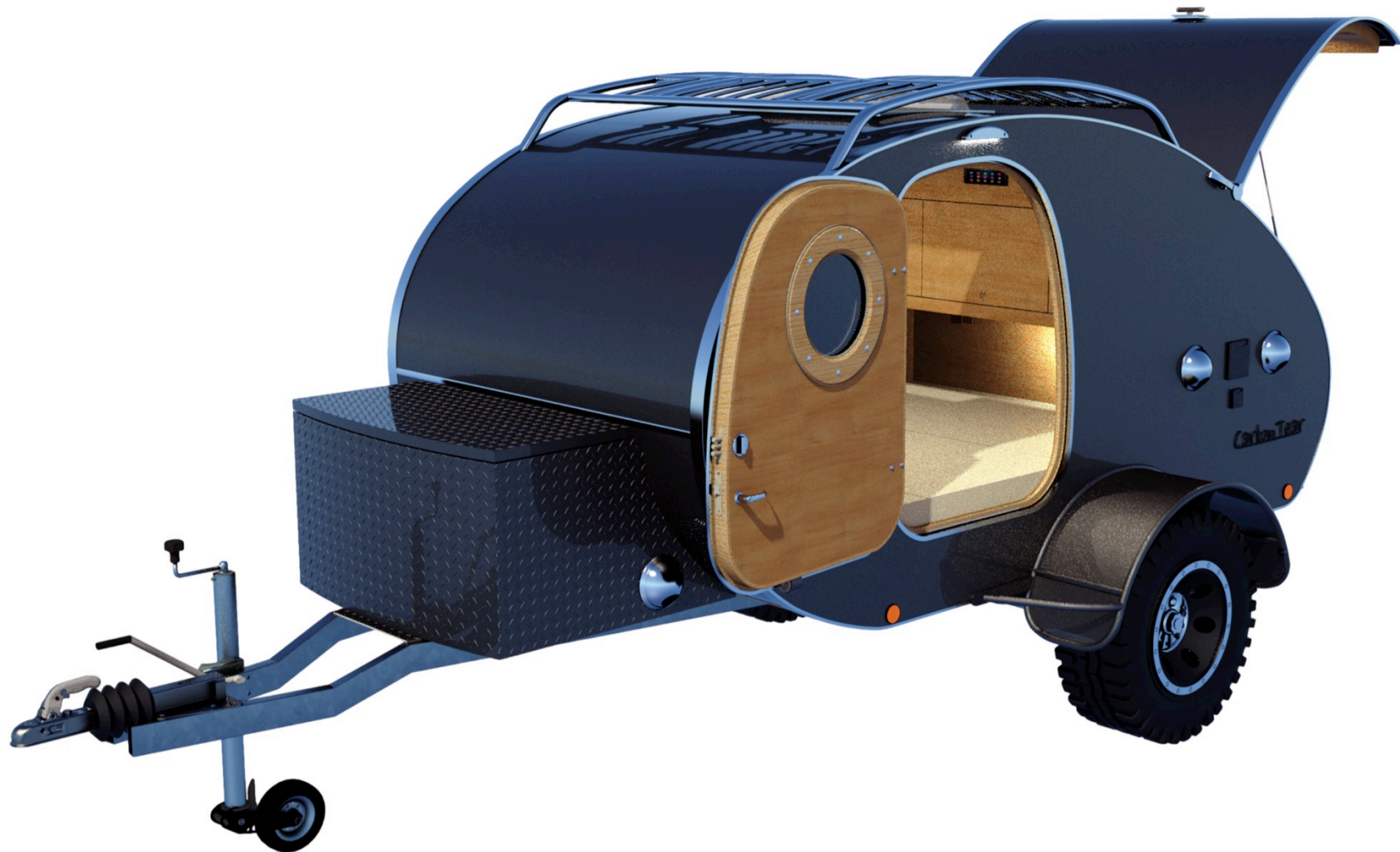

all rights reserved

GVWR 750kg - 1000kg

by: Piotr Goral

model year 2023

Carbontear MK I [®]

XR

NOMAD



independent suspension

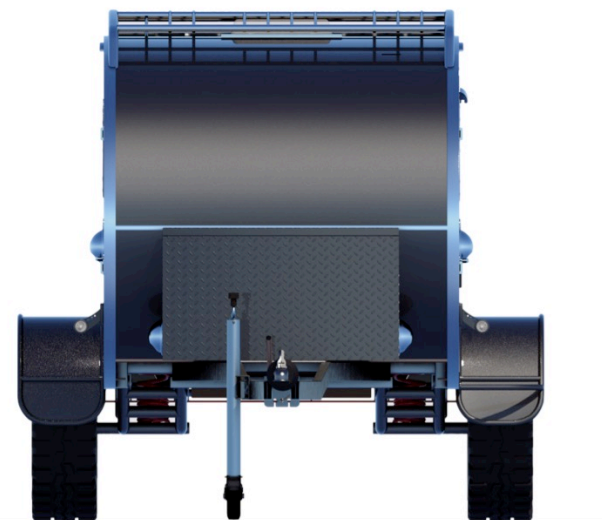

all rights reserved

GVWR 750kg - 1000kg

by: Piotr Goral

model year 2023

CarbonTear MK1[®]

XR

NOMAD

total length - 4780 mm
total width - 2200 mm
total height - 2180 mm
ride height - 400 mm

cabin length - 2040 mm
cabin width - 1510 mm
cabin height - 1180 mm



all rights reserved

dimensions

CarbonTear MK I [®]

XR

by: Piotr Goral

model year 2023

NOMAD

total length - 4780 mm
total width - 2200 mm
total height - 2180 mm
ride height - 400 mm

cabin length - 2040 mm
cabin width - 1510 mm
cabin height - 1180 mm



all rights reserved

dimensions

by: Piotr Goral

model year 2023

CarbonTear MK I [®]

XR

NOMAD

total length - 4780 mm
total width - 2200 mm
total height - 2180 mm
ride height - 400 mm

cabin length - 2040 mm
cabin width - 1510 mm
cabin height - 1180 mm

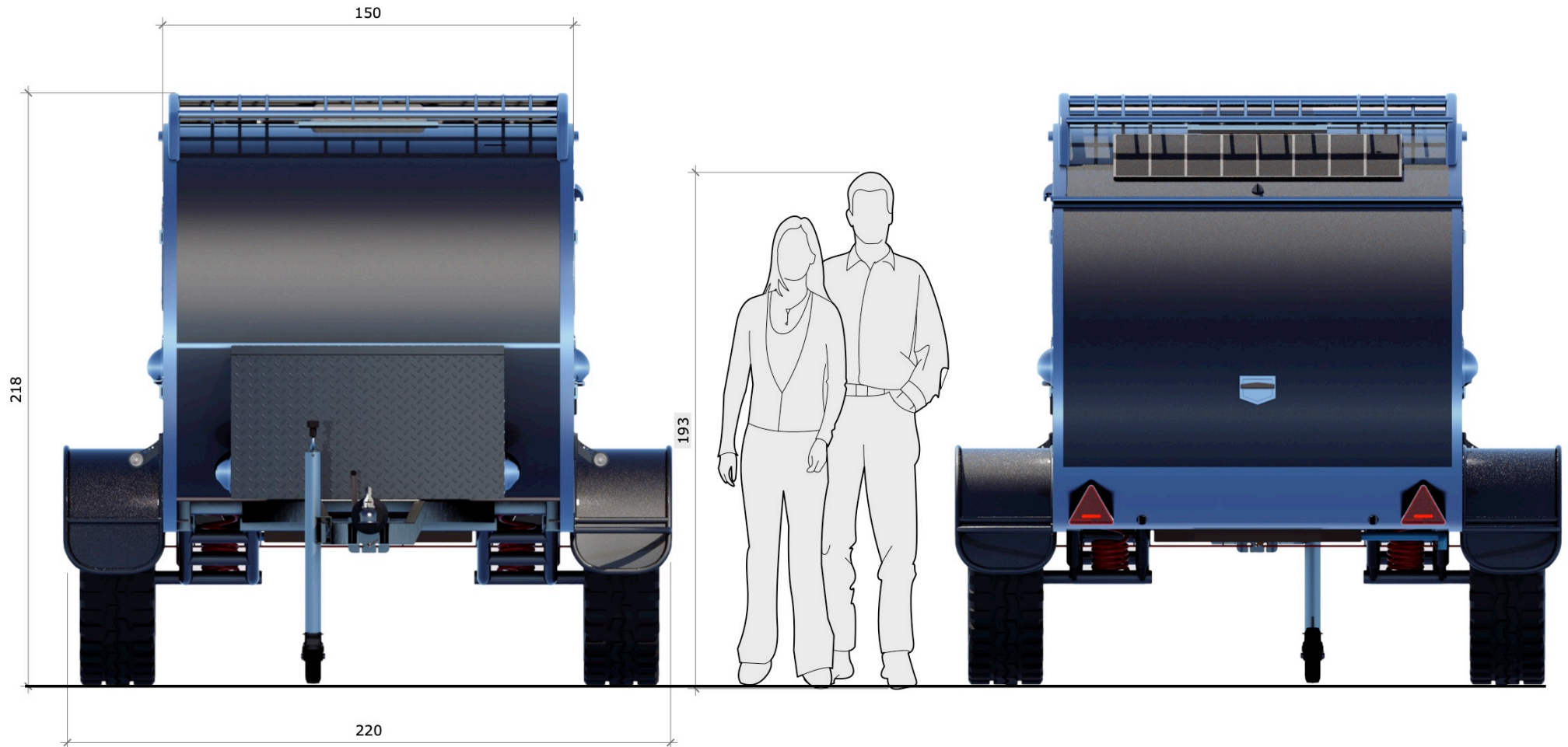

all rights reserved

dimensions

by: Piotr Goral

model year 2023

Carbondtear MK I [®]

XR

NOMAD

total length - 4780 mm
 total width - 2200 mm
 total height - 2180 mm
 ride height - 400 mm

cabin length - 2040 mm
 cabin width - 1510 mm
 cabin height - 1180 mm

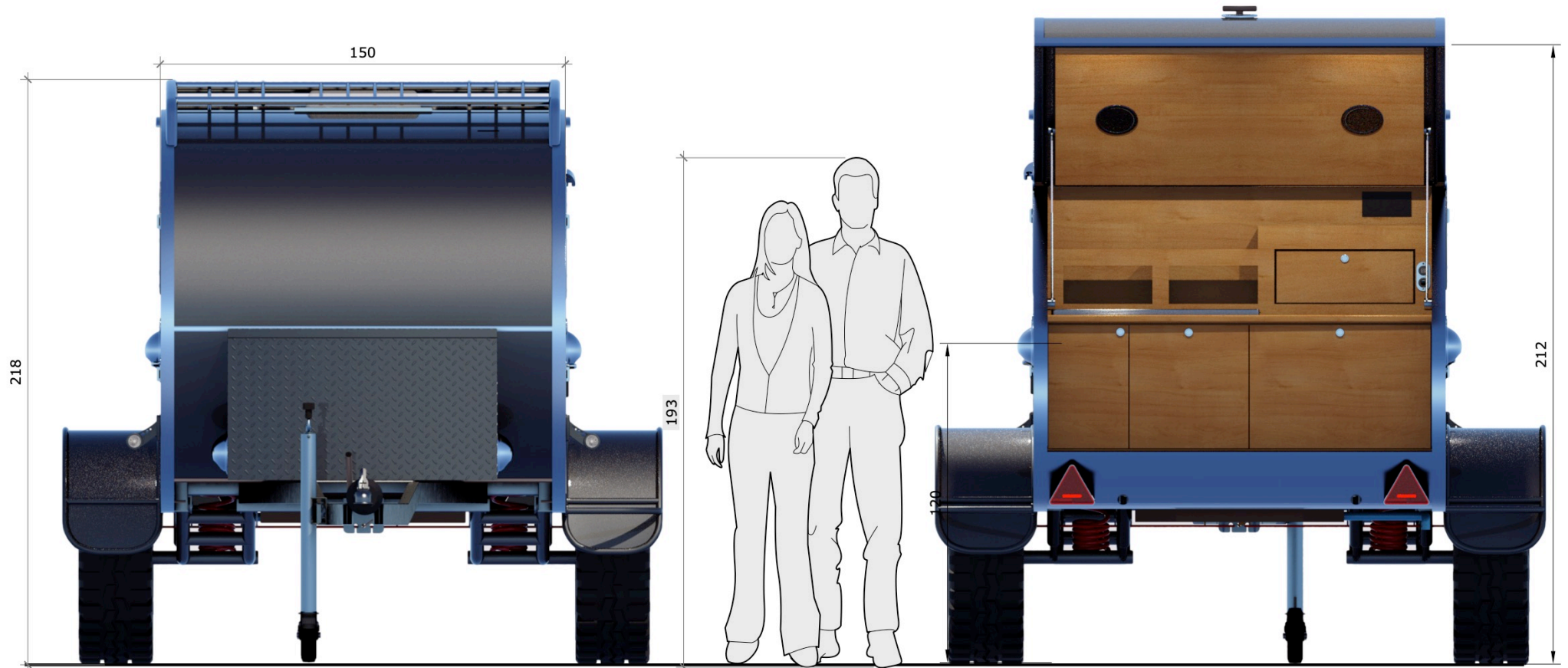

all rights reserved

dimensions

by: Piotr Goral

model year 2023

Carbontear MK I [®]

XR

NOMAD

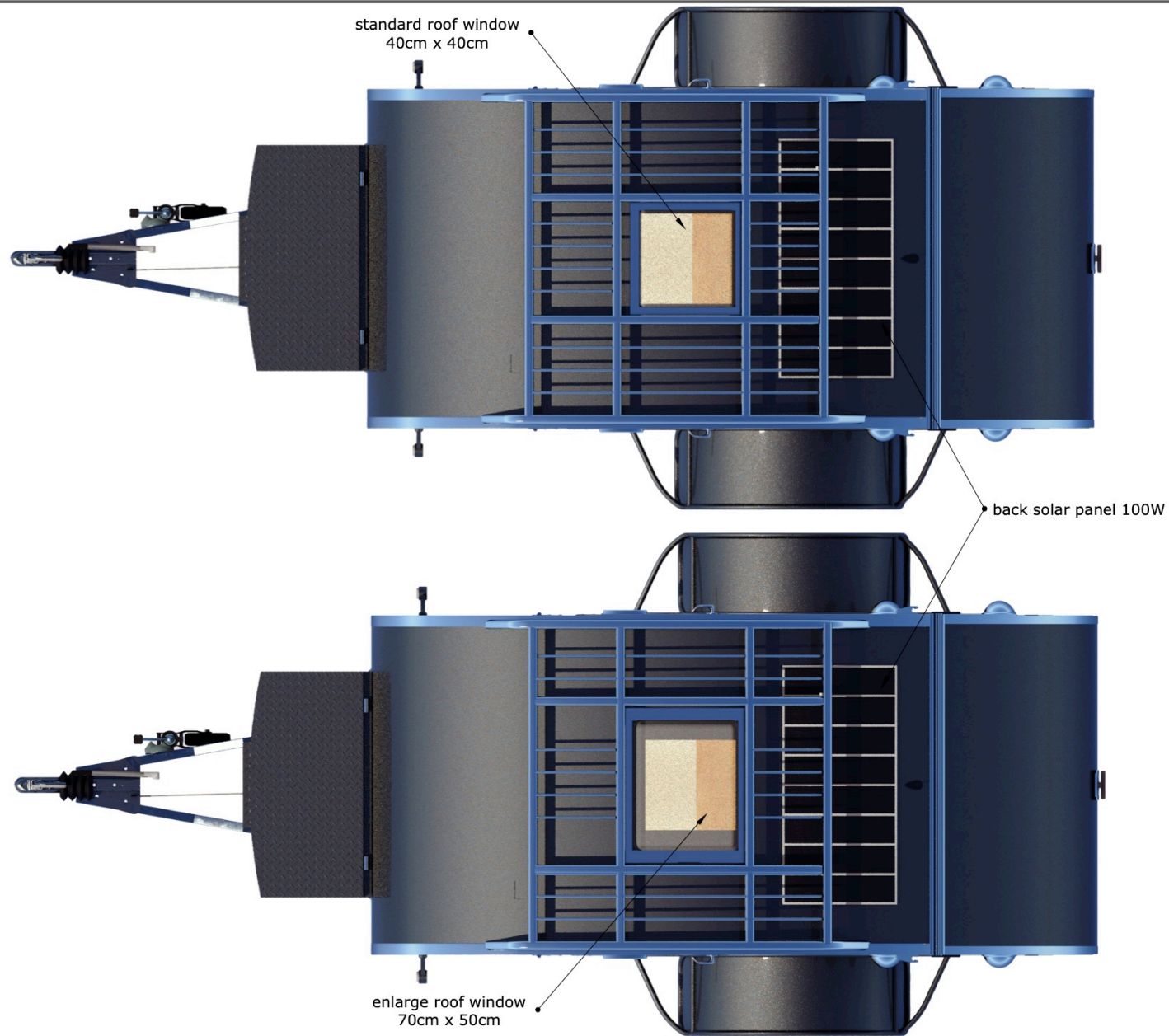

all rights reserved

roof windows

by: Piotr Goral

model year 2023

Carbontear MK I [®]

XR

NOMAD

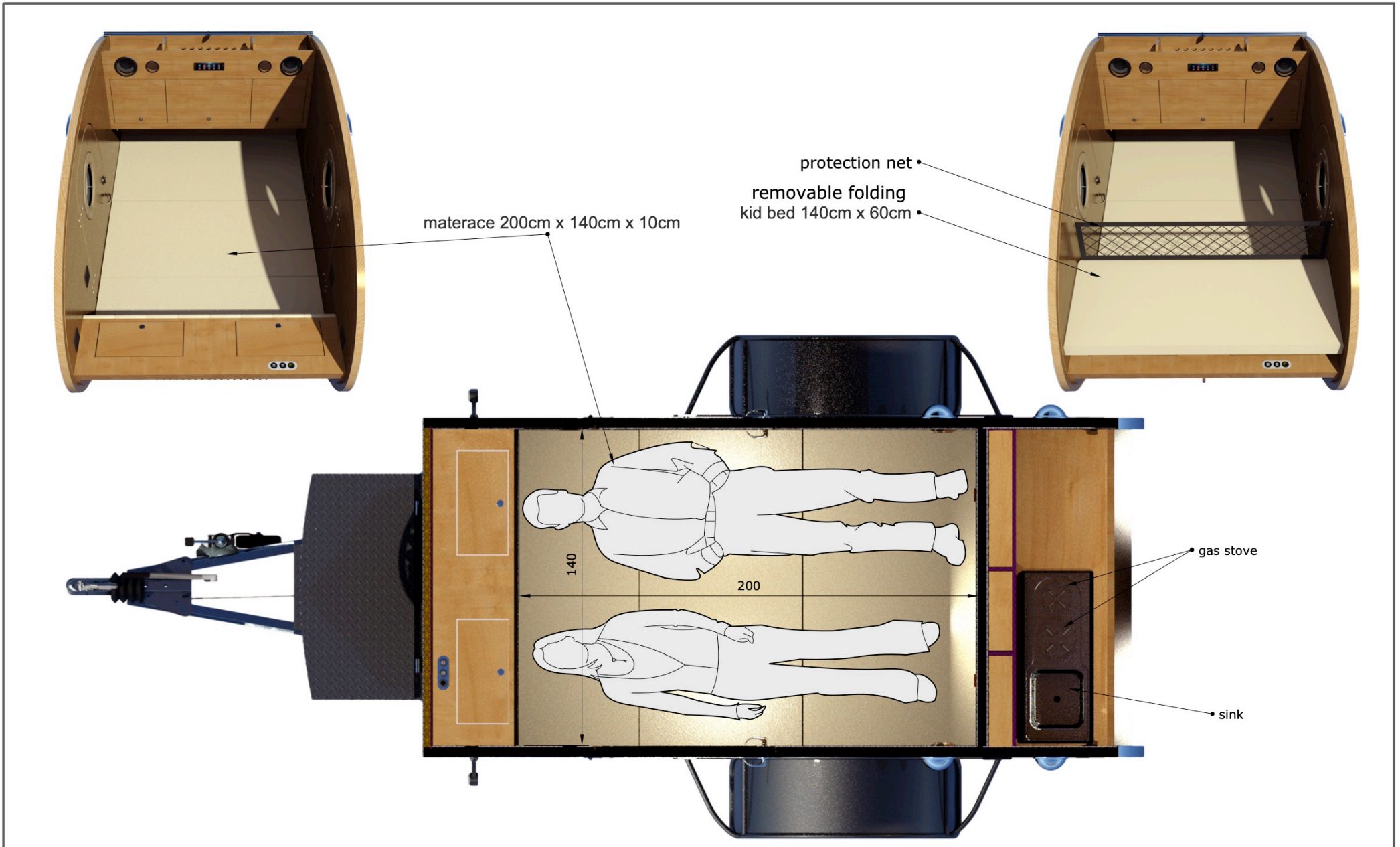

all rights reserved	sleeping room	Carbontear MK I [®]	XR
by: Piotr Goral	model year 2023		NOMAD



• 230V

• USB x 2

• 12 V

• 230V

• folding table



• loudspeakers

• stereo

all rights reserved

sleeping room

by: Piotr Goral

model year 2023

CarbonTear MK I [®]

XR

NOMAD

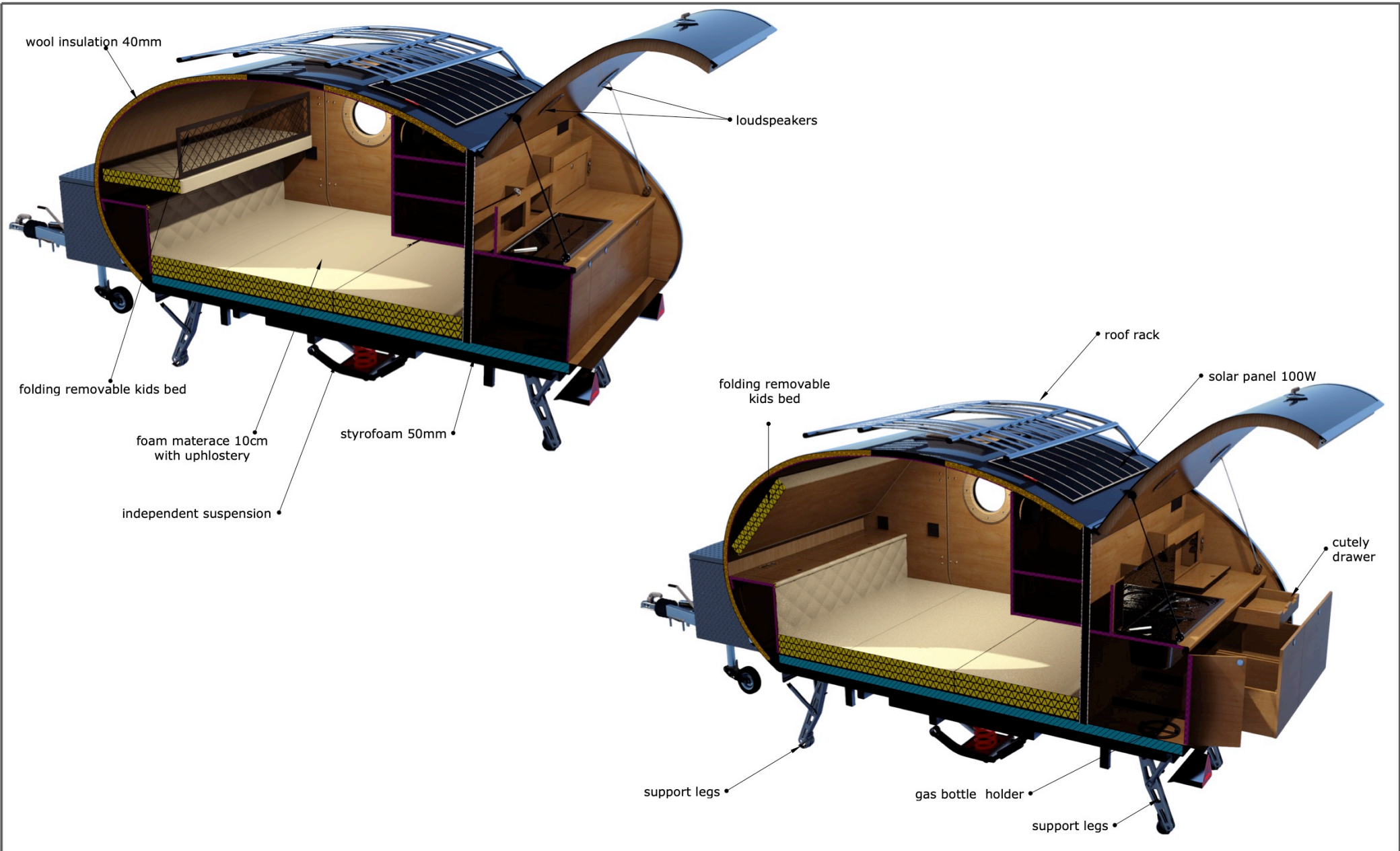

all rights reserved

A-A cut

by: Piotr Goral

model year 2023

Carbondtear MK I [®]

XR

NOMAD

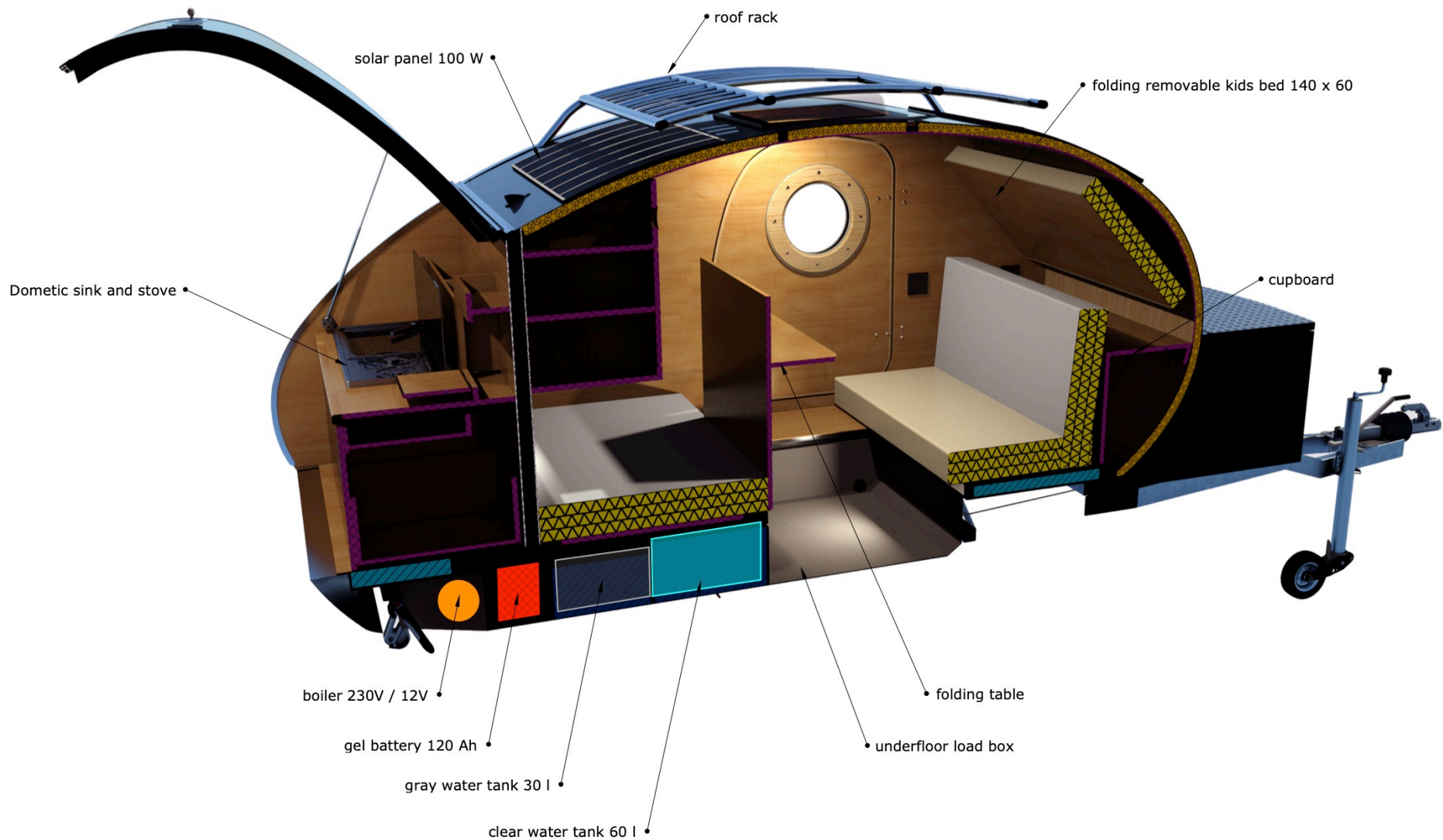

all rights reserved

A-A cut

by: Piotr Goral

model year 2023

CarbonTear MK I [®]

XR

NOMAD

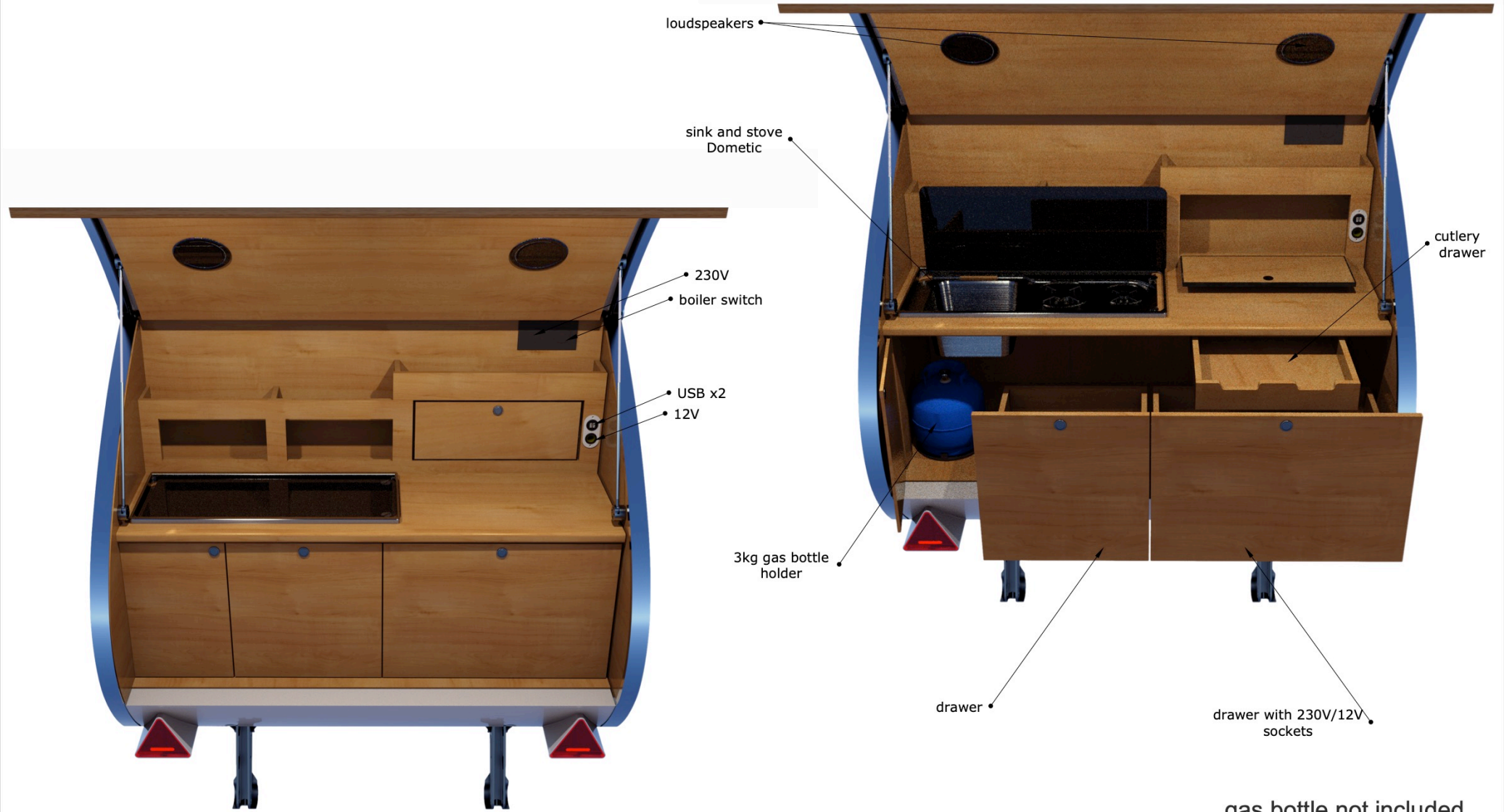

gas bottle not included

all rights reserved

kitchen

by: Piotr Goral

model year 2023

Carbontear MK I [®]

XR

NOMAD

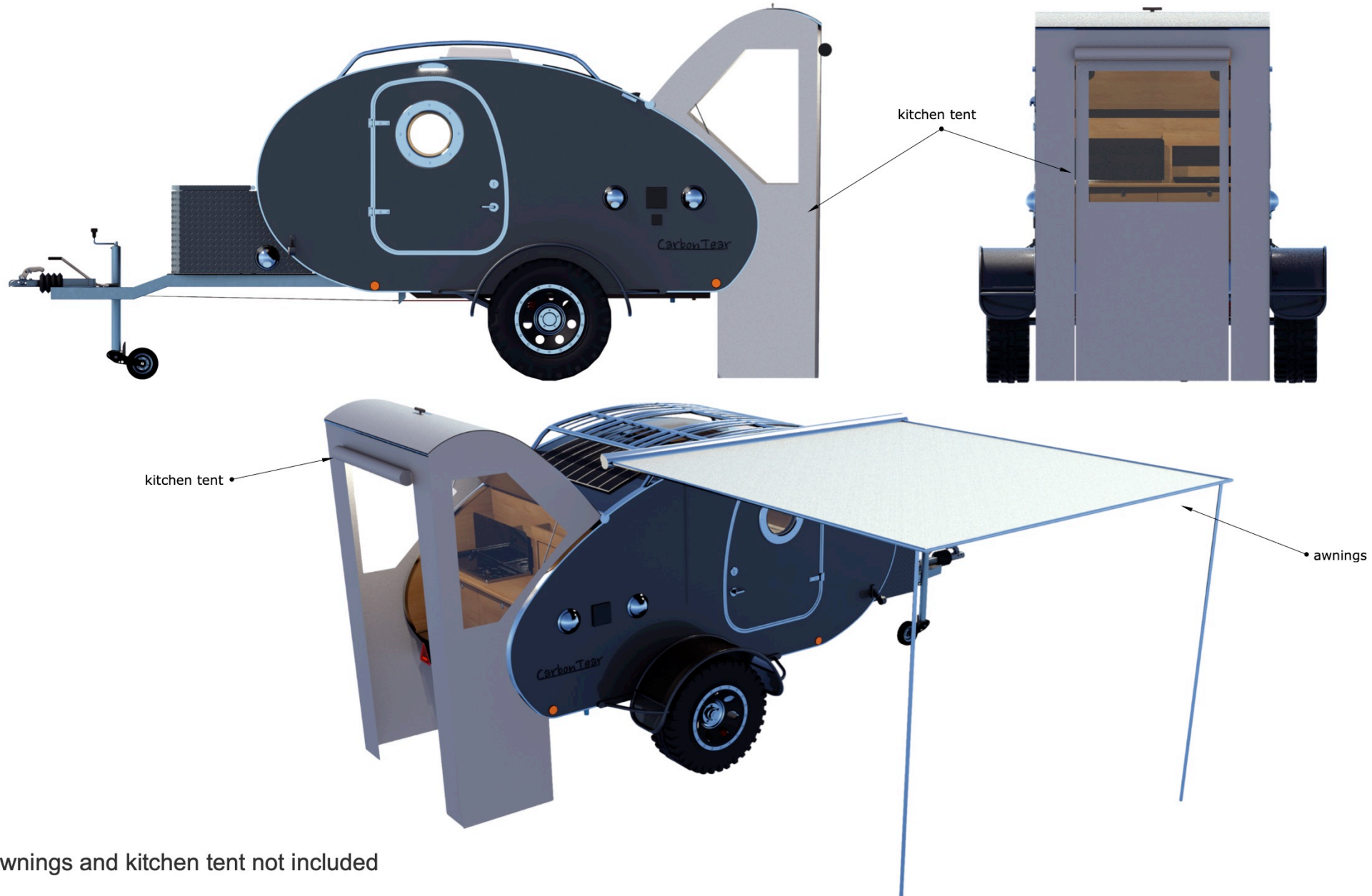

awnings and kitchen tent not included

all rights reserved	kitchen tent and awning	CarbonTear MK1 [®]	XR
by: Piotr Goral	model year 2023		NOMAD

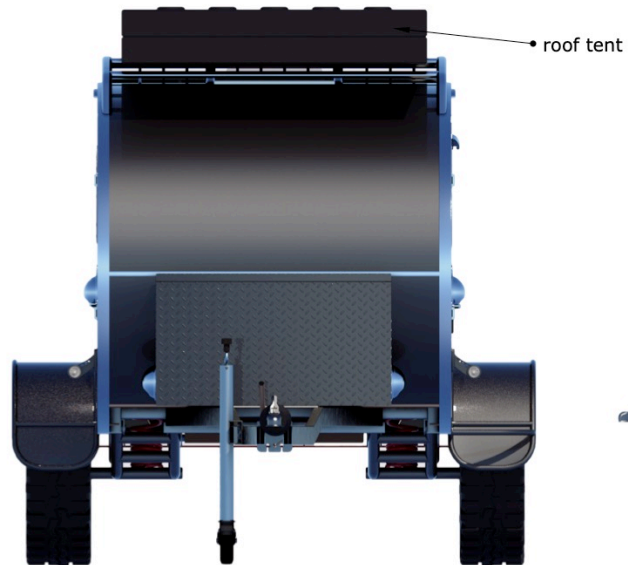

roof tent, bike rack and bicycles not included

all rights reserved	roof tent	CarbonTear MK1 [®]	XR
by: Piotr Goral	model year 2023		NOMAD



standard tow hook
for bike rack



surfing, bike rack and
bicycles not included

all rights reserved	bikes and surfing	CarbonTear MK1 [®]	XR
by: Piotr Goral	model year 2023		NOMAD

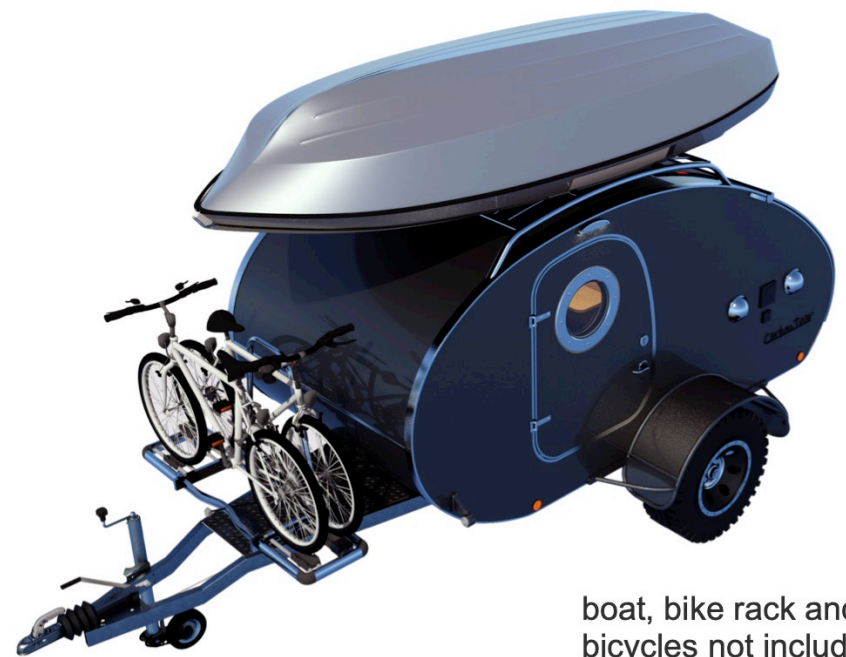

boat, bike rack and bicycles not included

all rights reserved

aluminium boat

by: Piotr Goral

model year 2023

CarbonTear MK I [®]

XR

NOMAD



all rights reserved	body colours	Carbon [®] tear MK I	XR
by: Piotr Goral	model year 2023		NOMAD

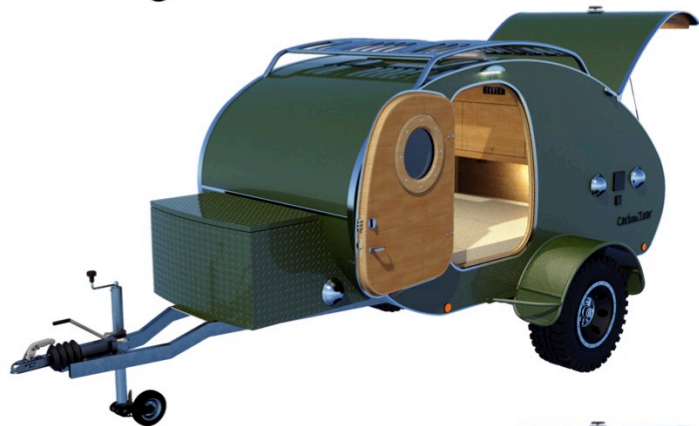
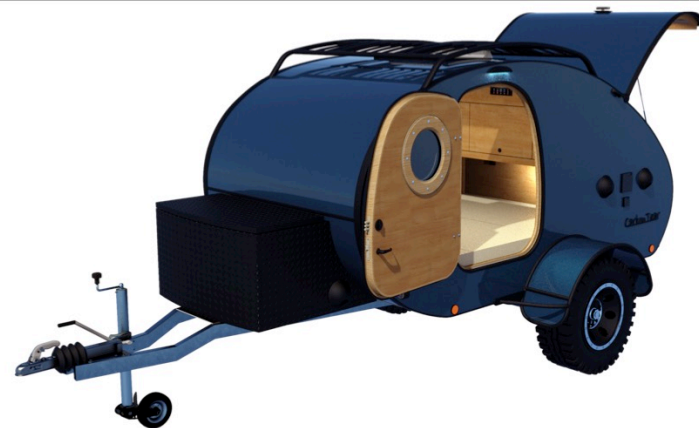
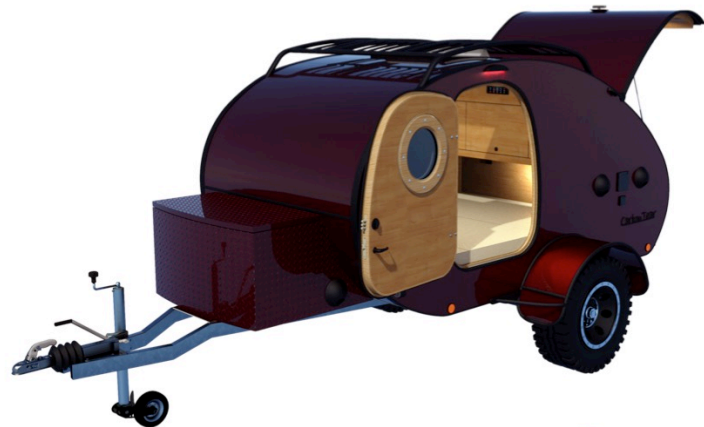

all rights reserved

body colours

by: Piotr Goral

model year 2023

CarbonTear MK1[®]

XR
NOMAD

textile upholstery



all rights reserved

upholstery

by: Piotr Goral

model year 2023

Carbontear MK I [®]

XR

NOMAD



Satin Black Pro Comp 5129



HE900 Gloss Black Helo



XD 129 Holeshoot Satin



Yokohama Geolandar AT G015



West Lake SL 366 MT



Cooper Discoverer S/T MAXX

all rights reserved

rims and tyres

by: Piotr Goral

model year 2023

Carbontear MK I [®]

XR

NOMAD

Specification in standard:

- chassis steel covered by zink
- body construction ash wood frame
- independent suspension with brakes
- alloy rims 16 " / 17"
- 33" tyres
- supporting feet x 4
- interior finishing – oak veneer
- materace with upholstery
- external wall finishing wrap foil
- roof finishing wrap foil
- details, finishing stripes brushed aluminium
- led lights x 6
- sleeping room furnishing with oak veneer
- kitchen furnishing with oak veneer
- folding table in the floor
- opening skylight 40cm / 40cm
- 12V/230V electrics
- external 230V connector
- 110W solar panel
- 120Ah gel battery
- audio system with 4 speakers
- 12/230 V boiler combo
- 12V charge socket x 2
- USB port x 4
- Dometic 2 stove kitchen with sink
- gas bottle holder
- roof rack 150 kg
- water tank 60 l gray water
- water tank 30 l clear water
- external shower connector with shower device
- front box on drawbar with 230V / 12V sockets

STANDARD	23 700 Euro
OPTIONS	
Eberschpracher heating system with remote control	1 600 Euro
kids bed 140cm x 60cm	400 Euro
awnings THULE OMNISTOR 260cm x 260cm	1 300 Euro
awnings DOMETIC 260cm x 260cm	800 Euro
enlarge roof widow Dometic 70cm x 50cm	350 Euro
coupling device with stabilizer	320 Euro
Dometic fridge 31 l	850 Euro
roof tent basic	1 750 Euro
cutlery drawer	650 Euro
hook for bicycle rack on towbar	320 Euro
roof boat holder	540 Euro

Price in Euro for standard specification
excluded VAT tax 23 700 Euro

loco: Lublin Poland

time of manufacturing 12 weeks from order

all rights reserved	specification	Carbon [®] tear MK I	XR
by: Piotr Goral	model year 2023		NOMAD